

Fabric expansion joints

www.roth-kompensatoren.de





- ▶ Introduction | 1.1
- ▶ Overview of Materials | 1.2
Insulation Notes | 1.4
- ▶ Constructive Types | 1.5
- ▶ Methods of Attachment | 1.10
Clamps | 1.10
Retaining Bars | 1.10
Flange Connection | 1.11
- ▶ Pre-assembled Kits | 1.11
- ▶ Installation and Servicing Instructions | 1.12
Storage | 1.12
Assembly Preparations | 1.12
Installation | 1.12
Service and Maintenance | 1.12
Important Information | 1.13
Installation Service | 1.13



Fabric expansion joints

Introduction

Fabric expansion joints are flexible elements capable to compensate largely without any stresses axial, lateral and angular movements in various piping systems. These types of expansion can occur concurrently. Appropriate designs are available to withstand vibration and torsion as well.

When installing, note that fabric expansion joints are not load-bearing elements of the pipeline. It is therefore important to ensure that the fixed points and support points are properly located. For more information regarding installation and maintenance procedures please check “Installation and Servicing Instructions” on page 1.12.

Although fabric expansion have joints various applications, ROTH fabric expansion joints are mainly used with gaseous media and bulk media in areas such as:

- ▶ Coal, oil and gas-fired steam power plants;
- ▶ Flue-gas desulphurization systems (DeSO_x);
- ▶ Nitrogen oxide removal systems (DeNO_x);
- ▶ Waste incineration plants;
- ▶ Chemical plants;
- ▶ Refineries;
- ▶ Cement industry;
- ▶ Lime works;
- ▶ Metallurgical plants;
- ▶ Painting and drying systems;
- ▶ Industrial furnaces;
- ▶ Ventilation systems ;
- ▶ De-dusting and filter installations;
- ▶ Fire protection systems etc.

Designing and manufacturing fabric expansion joints is a complex process which requires detailed information about the application, the working environment and the dimensions of the equipments or pipings. ROTH fabric expansion joints can be made from one single layer of fabric or they can have several layers glued or sewed together according to each application requirements.

The structural design of fabric expansion joints and their layers are largely determined by the following:

- ▶ Duct shape;
- ▶ Location;
- ▶ Installation conditions;
- ▶ Leak-proof requirements;
- ▶ Medium;
- ▶ External influences;
- ▶ Overpressure or vacuum;
- ▶ Temperature;
- ▶ Degree of movement;
- ▶ Fluid velocity;
- ▶ Moisture occurrence;
- ▶ Solid components of medium.

With timely planning, suitable and efficient designs can be elaborated for practically all variables.

Backed by many years of practical experience and comprehensive test procedures, we are able to offer the very best in consultation. The high quality of our fabric expansion joints is ensured by the choice of high-grade materials and their appropriate processing. Correct installation is another factor that determines the operational effectiveness of fabric expansion joints. We will be pleased to advise you or to provide expert assembly engineers on request.

Welded or flanged internal baffles are recommended depending on the operating conditions. Similarly, the mounting configuration for fabric expansion joints depends on diameter, structural design, layer structure and leak-proof requirements, see also page 1.10 -1.11.

Overview of Materials

ROTH fabric expansion joints are manufactured without any asbestos as a matter of principle. Insulation is provided nowadays by glass and silicate materials, which also serve as a substrate for various coating. Sealing foils and fully vulcanized elastomers are also used.

The suitability and durability of an expansion joint are determined less by structure of an individual layer than by correct composition of materials and appropriate processing. Both, practical experience and the Know-How of the expansion joint manufacturer are essential in this context.

The following table contains information regarding the compatibility of the most common materials used in the construction of fabric expansion joints against the most common chemical substances: acids and lyes. Also, the maximal temperature resistance (in operation) for each of these materials is showed in the second column.

Material overview	Temperature resistance max. [°C]	Chemical resistance		Description
		Acids	Lye	
Insulating material				
Ceramic fiber	1250 °C	+	+	For loose filling or quilted in fabric, also available incorporated in expansion joint.
Mineral wool	750 °C	○	○	For loose filling or quilted in fabric, also available incorporated in expansion joint.
Insulating glass	500 °C	+	+	Glass mat, also for use in some types of shaped fabric expansion joints.

Material overview	Temperature resistance max. [°C]	Chemical resistance		Description
		Acids	Lye	
Uncoated fabric				
INCONEL	1250°C	+	+	Woven ceramic fiber with INCONEL reinforcement.
Thermosil 650H	1100°C	+	+	Silicate fabric, extremely resistant to acids and temperature.
Thermotex 1100 HT	700 °C	+	+	Special fabric with high-temperature finish.
Thermotex 1100 NIRO	600 °C	+	+	Woven mineral fiber with stainless steel wire reinforcement ≈ 1100 g/m ² .
Glastex 1000	550 °C	+	+	Special glass fabric with high temperature resistance and good insulating effect, ≈ 1000 g/m ²
Glastex 800	500 °C	+	+	Glass fiber fabric, high tensile strength, ≈ 800 g/m ² .
Glastex 440	500 °C	+	+	Glass fiber fabric, high tensile strength, ≈ 440 g/m ² .
Aramid	200 °C	+	+	High-strength fabric for extreme mechanical loads.
Stainless steel 1.4301 1.4828	600-1000 °C	+	+	Fine wire-netting, choice of material depends on requirements.
Coated fabric				
VITON-Glastex 1 VITON-Glastex 2	180 °C	+	+	Glass fiber fabric with VITON-coating, excellent chemical resistance.
PTFE Glastex 20/600	280 °C	+	+	Glass fiber fabric, one side with PTFE-Foil 0,2 mm, compound material.
PTFE Glastex 20/10/600	280 °C	+	+	Glass fiber fabric, one side 0,2 mm, other side 0,1 mm PTFE-foil, compound material.
TFM-Glastex	280 °C	+	+	Glass fiber fabric, one side with TFM-Foil 0,4 mm, compound material.
PTFE-Glas 15	280 °C	+	+	PTFE-covered glass fabric, 0,15 mm thickness
Silglas 1 Silglas 2	180 °C	-	O	Glass fabric, one side/both sides with silicone-coating grey or white.
Silaramid 1 Silaramid 2	150 °C	-	O	Aramid fabric, one side/both sides with silicone-coating grey or white.

Material overview	Temperature resistance max. [°C]	Chemical resistance		Description
		Acids	Lye	
Coated fabric				
Alufix 1 Alufix 2	150 °C	–	–	Glass fabric, one side/both sides with PU-coating, grey hardly inflammable, oil resistant.
Aluglas 430	200 °C	–	–	Glass fabric, one side with aluminum-coating.
Glastex 4435	400 °C	+	+	Glass fabric, one side with stainless steel coating.
Hypatex	120 °C	+	+	Polyester fabric, both sides with hypalon-coating.
Polytex	70 °C	+	+	Polyester fabric, both sides with PVC-coating.
Foils				
PTFE 25	260 °C	+	+	PTFE-foil 0,25 mm thick, virginal
Silicone	180 °C	–	O	Silicone-foil 1,5 mm or 2,5 mm thick, for high tightness requirements.
FPM (z.B. / pl. Viton)	180 °C	+	+	FPM-foil with high chemical resistance.
Stainless steel, INCONEL	600 °C	+	+	Stainless steel foil, good chemical and thermal resistance, choice of materials depends on requirements.
Soft-PVC	90 °C	+	+	High chemical resistance.
EPDM Neoprene Perbunan Butyl Mipolam	80 °C	+	+	With different layer thickness, also with inner fabric layer.
Hypalon	120 °C	+	+	Hypalon-foil, 2,0 mm thick, high chemical resistance.

+ = Resistant; O = Conditionally Resistant; – = Not resistant.

Insulation Notes

Normally fabric expansion joints must not be included in external piping insulation to allow the calculated and necessary heat transfer. If you would like to install an insulation, please contact us, such that we may choose a special design for your expansion joints.

The piping insulation must not contact the expansion joint flanges under all circumstances. Generally a distance of at least 80 mm has to be kept between piping insulation and expansion joint. The duct insulation at ROTH fabric expansion joints has to be approved by our technical department. The installation of outer protection shields at the expansion joints has to be approved too.

► Constructive Types

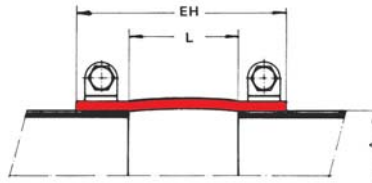

Type 11

Tube expansion joint, for mounting with clamps directly on the pipeline, standard model.

Capable movement:

axial: $0,10 L - 0,30 L$
lateral: $0,05 L - 0,20 L$

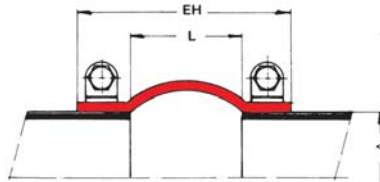

Type 12

Tube expansion joint with preformed convolution, greater expansion compensation than Type 11.

Capable movement:

axial: $0,20 L - 0,50 L$
lateral: $0,10 L - 0,20 L$

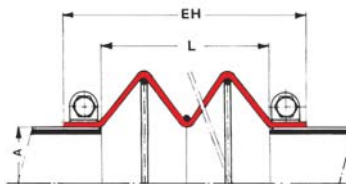

Type 14

Bellows expansion joint for mounting with clamps, with stainless steel support rings, for large expansion with internal or external pressure.

Capable movement:

axial: $0,30 L - 0,50 L$
lateral: $0,15 L - 0,25 L$

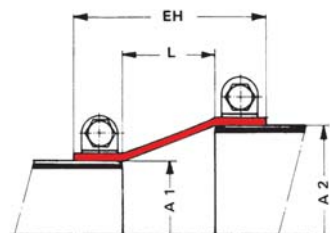

Type 15

Conical tube expansion joint for mounting with clamps, for bridging differed pipe or conduit diameters, usual configuration for fire-protection expansion joints.

Capable movement:

axial: $0,30 L - 0,50 L$
lateral: $0,10 L - 0,15 L$

Type 16

Tube expansion joint with external convolution for large movements, mounting with clamps, for different connecting cross-sections.

Capable movement:

axial: $0,30 L - 0,60 L$
 lateral: $0,15 L - 0,30 L$

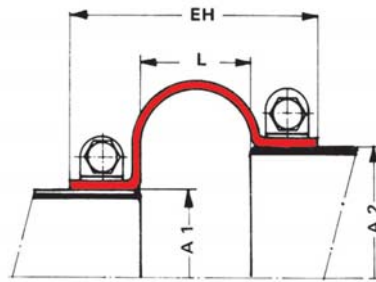

Type 21

Flat tube expansion joint, mounted on extended angle flange, for high temperature applications, baffle recommended, insulation can be installed locally or incorporated in the expansion joint.

Capable movement:

axial: $0,10 L - 0,30 L$
 lateral: $0,05 L - 0,20 L$

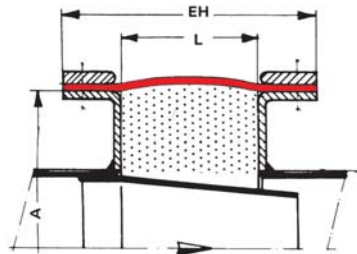

Type 22

Tube expansion joint with preformed convolution, greater expansion compensation than type 21.

Capable movement:

axial: $0,20 L - 0,50 L$
 lateral: $0,10 L - 0,20 L$

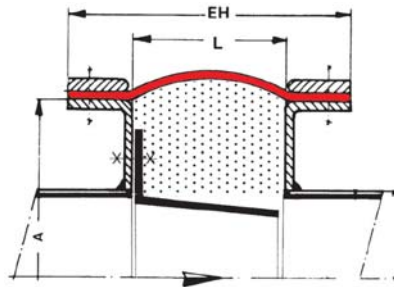

Type 23

Bellows expansion joint for extreme expansion compensation, also with integral stainless steel support rings, for internal and external pressure.

Capable movement:

axial: $0,40 L - 0,70 L$
 lateral: $0,15 L - 0,25 L$

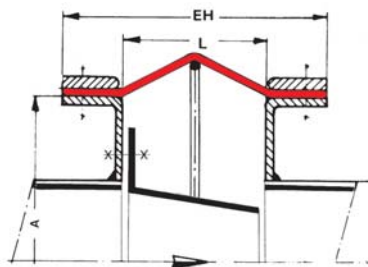

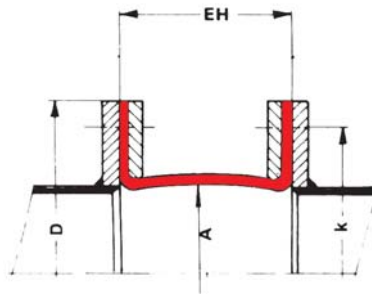

Type 31 (without baffle)

Flange expansion joint, U-design conventional standard model.

Capable movement:

axial: 0,10 L – 0,30 L
lateral: 0,05 L – 0,20 L

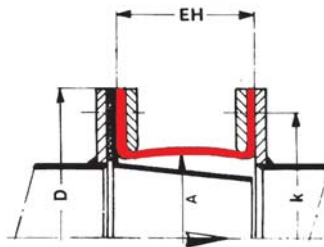

Type 31 (with baffle)

Flange expansion joint, U-design conventional standard model, flanged baffle.

Capable movement:

axial: 0,10 L – 0,30 L
lateral: 0,05 L – 0,20 L

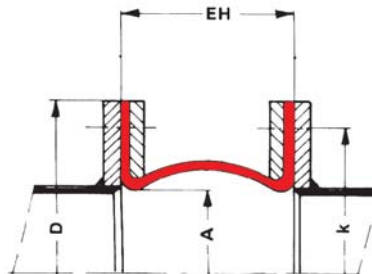

Type 32

Flange expansion joint with convex bellows, for greater expansion compensation and internal pressure.

Capable movement:

axial: 0,20 L – 0,50 L
lateral: 0,10 L – 0,20 L

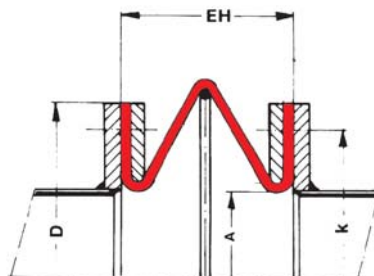

Type 33

Bellows expansion joint, flange model for extreme expansion compensation, also with integral stainless steel supporting for internal and external pressure.

Capable movement:

axial: 0,40 L – 0,70 L
lateral: 0,15 L – 0,25 L

Type 35

Membrane expansion joint, for shaft and tubular bushings.

Capable movement:

* compensation depending of detailed design.

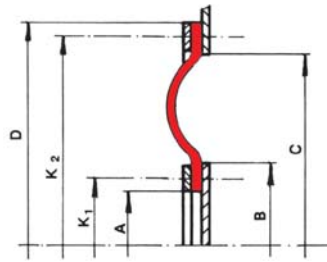

Type 42

Flange expansion joint with concave bellows for greater expansion compensation and external pressure.

Capable movement:

- axial: 0,20 L – 0,50 L
- lateral: 0,10 L – 0,20 L

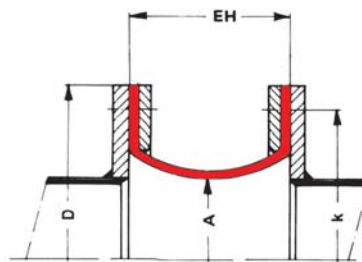

Type 43

Flange expansion joint with internal convolution, for extreme expansion compensation and external pressure.

Capable movement:

- axial: 0,30 L – 0,80 L
- lateral: 0,15 L – 0,30 L

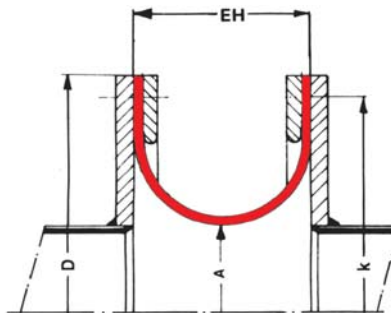

Type 45

Flange expansion joint, U-design external bellows, special design with internal bolts.

Capable movement:

- axial: 0,10 L – 0,30 L
- lateral: 0,05 L – 0,20 L

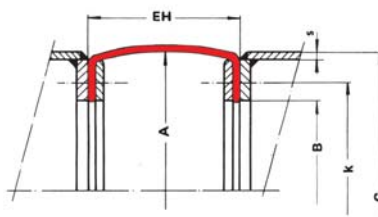

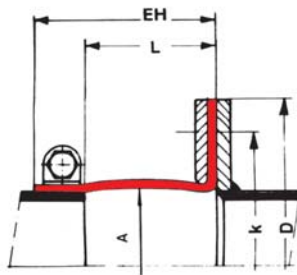

Type 51

Tube-flange expansion joint for identical connecting cross-sections.

Capable movement:

axial: $0,10 L - 0,30 L$
lateral: $0,05 L - 0,20 L$

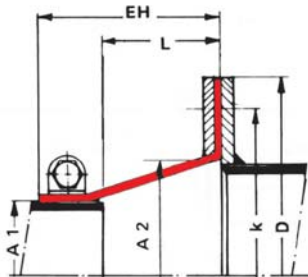

Type 52

Conical tube-flange expansion joint for different connecting cross-sections.

Capable movement:

axial: $0,30 L - 0,50 L$
lateral: $0,10 L - 0,15 L$

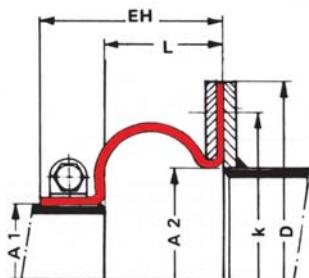

Type 53

Tube-flange expansion joint with external convolution, for extreme expansion compensation for identical or different connecting cross-sections.

Capable movement:

axial: $0,30 L - 0,60 L$
lateral: $0,15 L - 0,25 L$

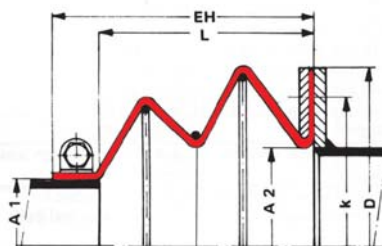

Type 54

Bellows expansion joint, tube-flange model, for identical or different connecting cross-sections, with stainless steel support rings.

Capable movement:

axial: $0,40 L - 0,70 L$
lateral: $0,15 L - 0,25 L$

▶ Methods of Attachment

Fabric expansion joints are designed and manufactured according to the operating and leak-proof requirements imposed on them. The resistance to leaks is, however, only as good as permitted by the chosen method of attachment and the surface quality of the sealing surfaces. The correct method of attachment must therefore be selected in order to ensure the operational reliability of the expansion joint.

Clamps

Clamps are a simple and low-cost form of attachment that does not require the drilling of the expansion joint. They are subject to the following operational limitations:

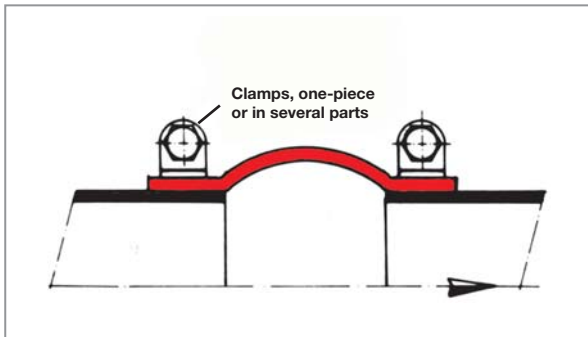

- ▶ For conventional clamp types, the attainable surface pressures are approx. 3 N/mm² up to DN 500 and approx. 1 N/mm² up to DN 1000;
- ▶ The pressure of the medium in the pipe must not exceed 100 mbar;
- ▶ The temperature of the medium should not exceed 300 °C, because the significant differences in the thermal expansion of the pipe and clamps can lead to overstretching and leaks when exposed to.

Please note that clamps are only suitable for circular cross-sections. Also, composite clamps must be installed with max. part lengths of 1000 – 2000 mm in order to achieve uniform radial forces at the circumference. Surface pressure of 5 N/mm², as usually required at the sealing surfaces of fabric expansion joints, cannot be achieved owing to the limited tensile strength with clamps.

Retaining Bars

With equivalent technical properties to those offered by flange connections, retaining bars are used to secure the simple tube expansion joints. Normally made out of carbon steel profiles with primer or galvanizations finish, retaining bars are a cheap solution for assembly.

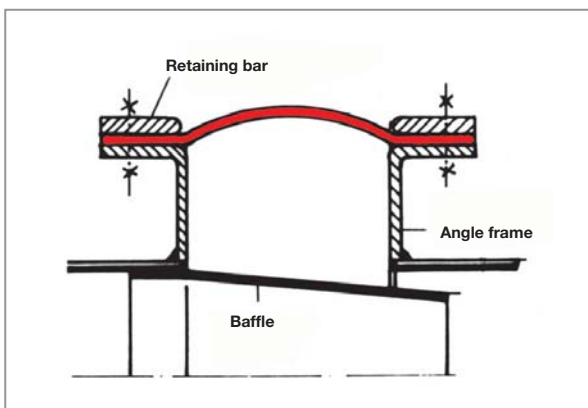

They are applied in cases where it is not possible to achieve with clamps assembly the radial forces needed/required for sealing purposes.

A common application for retaining bars is the case of rectangular and oval cross-sections expansion joints.

For information on the layout of the screw connections and appropriate strip dimensions see table, in the next section "Flange connection".

Flange Connection

Flange connections are regularly used for large round and rectangular cross-sections. It is the most favorable design for installation purposes. As with retaining strips, the required surface pressure at the static sealing area can be achieved by the appropriate choice of flange width and thickness, hole spacing and bolt size.

The following table contains empirically tested flange connection dimensions for reference purposes:

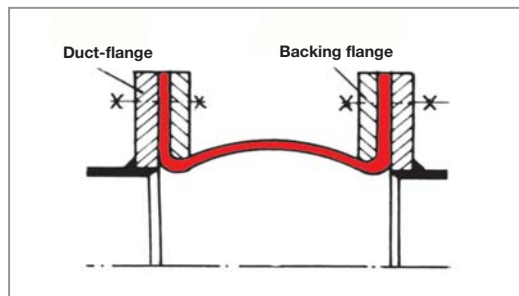

Flange width [mm]	Flange thickness [mm]	Hole spacing [mm]	Bolt size	Tightening torque [Nm]	Bolt force [N]
30	8	80	M10	20	11800
40	10	90	M12	35	17300
60	12	130	M16	85	31000

Compression of the expansion joint flange owing to the force exerted by the bolts can lead to permanent depressions in the area of the flange and slacking the bolts. Either take up the slack at the flange bolts with a torque wrench after commissioning or use appropriately dimensioned cup spring assembly at each bolt to allow self-adjustment.

► Pre-assembled Kits

ROTH fabric expansion joints can be supplied as a complete pre-assembled unit which can be welded or flanged to the duct. This will guarantee a perfect mounting of the expansion joint in factory, whilst the effort for installation on job site will be reduced to a minimum.



Pre-assembled kits are suitable for nearly all applications and temperatures. Nevertheless their main field of operation are exhaust expansion joints for gas turbines or flue-gas ducts where high temperatures may occur. Therefore steel parts for ROTH expansion joint kits will be manufactured in various material qualities depending on their operating conditions. For we apply high temperature carbon steels or heat resistant stainless steels, we may handle temperatures up to 1000 °C.

Especially for gas turbine applications fabric expansion joint kits are superior to stainless steel expansion joints because of their low spring rates and their excellent sound absorption. Whilst the efforts for installation are nearly the same, during operation significant lower reaction forces will occur. Thus no expensive bearings and fix points are required and the external loading of the gas turbine is reduced substantially due to lower reaction forces and moments at the connecting flanges. Pre-assembled ROTH fabric expansion joint kits are in service under various operating conditions for years now. Please benefit of our great experience and contact us. It will be a pleasure for us to give you comprehensive advice.

▶ Installation and Servicing Instructions

Storage

ROTH fabric expansion joints are delivered well secured and sufficiently packed. Until the time of installation they must be stored dry and clean and be not subjected to solar radiation.

Assembly Preparations

The following steps should be taken before and during assembling ROTH fabric expansion joints to ensure a proper installation:

- ▶ All packing materials should only be removed immediately before installation;
- ▶ Transportation devices should be removed as late as possible but before starting service;
- ▶ Verify that flange dimensions and bolt circles match at all connecting parts
- ▶ Check all edges and surfaces of the system components for burrs and pollution;
- ▶ Components not supplied by ROTH must not be sharp-edged. Edges which may contact the joint require a radius of at least 3 mm.

Installation

ROTH fabric expansion joints should be installed at the end, as a conclusion of the pipe work to prevent damages resulting from other work such as welding, grinding scaffolding etc. They also must be protected against sharp-edged objects or tools.

We deliver numerous different types of joints with a great variety of materials for various applications. Thus, the installation and especially the closing of open-ended expansion joints require a great number of different techniques and methods.

For comprehensive assistance we recommend our leaflets available for download on our website in the Documentation section:



- ▶ “ROTH Installation and Servicing Instructions”;
- ▶ “Closing Instructions for ROTH Fabric Expansion Joints”.

Service and Maintenance

Compared to stiff piping systems, expansion joints are limited-life-time components. According to strains and operating conditions, but at least every 3 months, routine inspections should be done (i.e. visual check-up, screw fixings). Solvents may damage the surface coatings of fabric expansion joints. Therefore, do not paint the joint or use any caustic cleansing agents or those containing solvents.

Important Information

Fabric expansion joints are no supporting components of the piping system, therefore the correct positioning of guides and fixed-points is of utmost importance. Inside and outside of ROTH fabric expansion joints are unmistakably marked. These marks must be observed in order to grant correct installation.

- ▶ Protect expansion joints against weld-sparks and sharp-edged objects whilst any work is carried out nearby;
- ▶ Lift pre-assembled joint kits only at marked transportation devices;
- ▶ Expansion joints have to be lifted with several spread loops or butt straps or have to be supported by plates;
- ▶ All dimensions and measures for installation must be strictly adhered to, otherwise no warranty can be given by manufacturer;
- ▶ PTFE-foils and coated fabrics tend to become brittle at low temperatures. Hence, fabric expansion joints made of these materials have to be handled with care at temperatures below +10 °C (50° F) and must not be installed at these temperatures;
- ▶ The allowable working temperature of the adhesives used during closing and mounting has to be sufficient to avoid burning!

Attention: If defects may cause the risk of injuries, appropriate safety devices must be supplied!

Note: The manufactured length (BH) is determined by taking into account the movements and assembly tolerances, so that the expansion joint may be installed without stress.

Installation Service

Our experienced service team is available immediately on job-site at any time. All installation and assembly work will be executed promptly and competently by our skilled workers. We also may provide a foreman who may support your workers. Of course, our team will be at your service for measuring up your mounting situation and for disassembly too.

Please do not hesitate to contact our service department (service may not be available in all countries, for more details please check our website).